

PRODUCT SPECIFICATION 产品规格书

NB25811M-5

1.8m INTEGRATED BATH
1.8 米浴缸(含裙边/去水)



(Rough-in Dimensions):

安装尺寸图:

(Unit): mm

单位: 毫米

(Size): 1800X800X600

尺寸: 1800X800X600

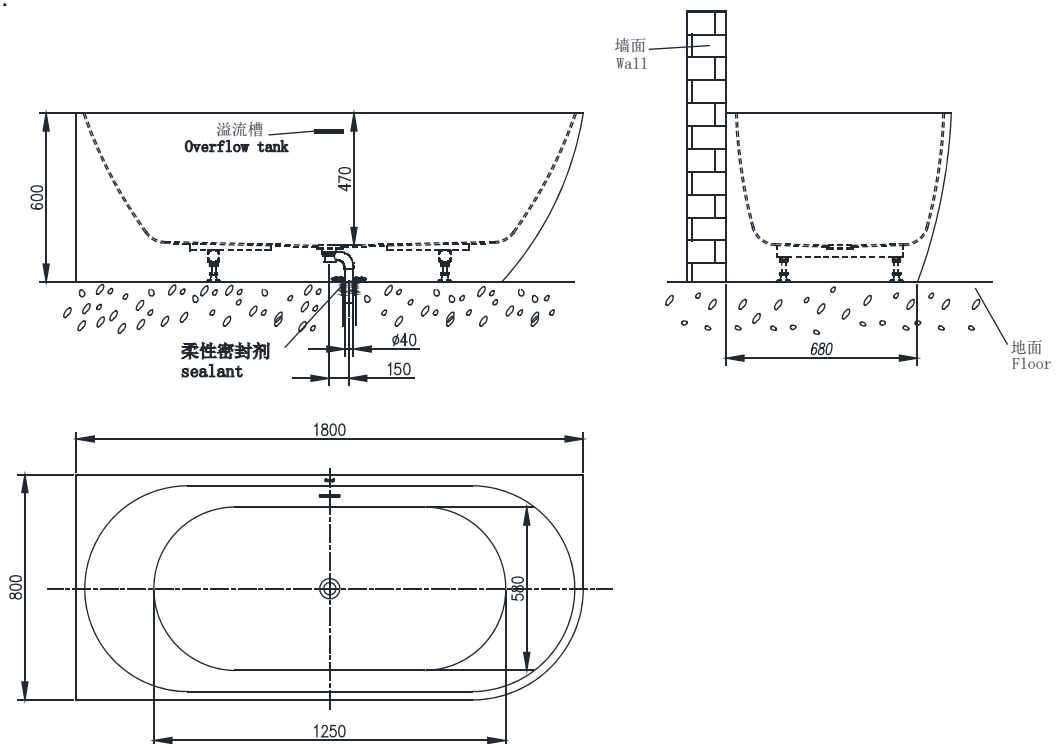

Item No. 品号	NB25811M-5
Capacity 容水量	Safety volume: 345L 浴缸安全容水量345升
Available Color 颜色	Matt White 哑光白色
Materials 材质	Acrylic 亚克力
Shipping Package 运输包装	浴缸包装 : L(长)1850 X W(宽) 850X H(高) 650mm (1set/1CTN 1个/1箱) G.W(毛重) : 56 kg

Remarks: With overflow function, Contains black copper press bath drain, black overflow grooves and plastic drain pipe. (L=400-1000mm)

备注: 带溢流功能, 包含黑色铜质弹跳去水器, 黑色溢流槽装饰条和塑料排污管(L=400-1000mm)。

INNOCI reserves the right to make changes or modifications on any of its products without advance notice.
INNOCI 艺耐公司保留不事先通知便改变或修改的权利

innoci

Innoci Sanitary ware Co.,Ltd
www.innoci.com

Version:A0

版本:A0